

The GENERAL RADIO EXPERIMENTER

VOL. 2 NO. 11

APRIL, 1928

The General Radio Experimenter is published each month for the purpose of supplying information of particular interest pertaining to radio apparatus design and application not commonly found in the popular style of radio magazine.

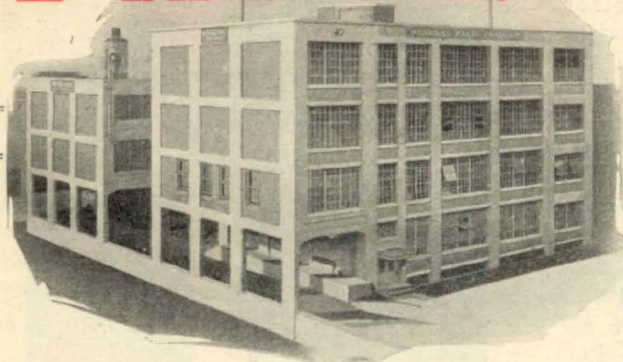

There is no subscription fee connected with the General Radio "Experimenter." To have your name included in our mailing list to receive future copies, simply address a request to the
GENERAL RADIO CO., Cambridge, Mass.

A Phonograph Amplifier

By A. R. WILSON, Engineering Department

The past year or two has seen remarkable strides being made in the design of audio amplifying equipment. Amplifiers and transformers have been developed to such a stage that it is difficult to see where an improvement in quality could be made. With the introduction of the new UX 250 power amplifier tube a far greater loud speaker volume is possible than heretofore since this tube is capable of delivering over three times the undistorted power of the UX 210 tube, long the favorite power tube for maximum volume and tone quality. These developments in the quality of radio transmission and reception have reacted on the phonograph industry and it became necessary for the designers of phonographs to look around for some means whereby their previously unchallenged supremacy could be regained. Thus came the electric phonograph known under various trade names as the Panatrop, the Electric Victrola, etc. These machines all use as their basis the modern high-grade audio amplifier instead of the old-fashioned sound box and horn. The horn gave way to the cone type of reproducer and the sound box itself was replaced by the electro-magnetic pick-up.

This latter piece of apparatus, although the smallest in the make-up of the electrical phonograph, is probably the most interesting of all components. Its function is to translate into electrical energy the

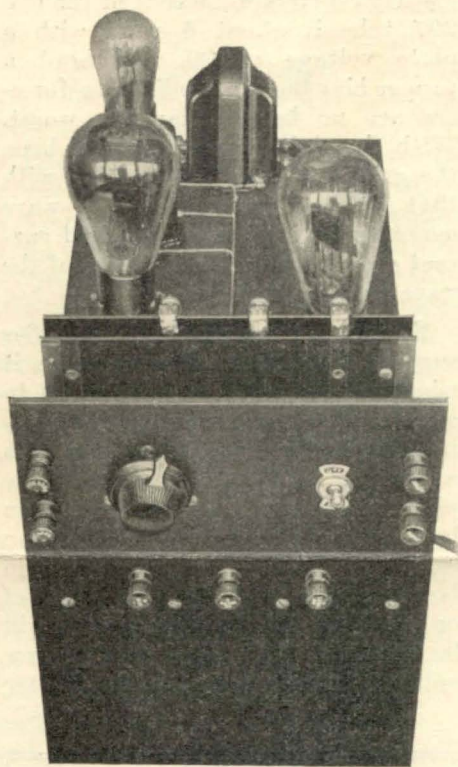

Fig. 1. Front View of Amplifier

vibratory motion of a needle traveling over the surface of a phonograph record. The vibration of the needle is utilized to generate current in an electric circuit. These changes in current represent the vibrations of the needle which in turn represent the sound originally impressed on the phonograph record.

The action of the magnetic pick-up is a reversal of the action of a loud speaker. The selection of a

good magnetic pick-up does not solve the problem of good reproduction because the audio frequency amplifier must be carefully built and use must be made of both a power tube and a speaker of good design. There are now on the market several types of very good magnetic pick-ups and it is the purpose of this article to describe an amplifier that was primarily designed for use with them.

In designing any audio amplifier, size, cost, etc., play a most important part in the final layout. The instrument desired in this case was a complete audio frequency amplifier capable of being used after the output of a standard magnetic pick-up and providing the speaker with a large degree of volume together with excellent tone quality and at the same time be combined with a plate supply, so that the complete unit might be operated from the standard 110 volt AC line. The final design of this amplifier involved a complete two-stage transformer coupled amplifier utilizing one UY 227 tube in the input stage and the new UX 250 power amplifier tube in the output stage.

The plate supply system consists of a half wave rectifier, filter, and potentiometer device so designed as to furnish plate voltage for the UX 250 tube, together with lower plate voltages for the UY 227 tube, and, if so desired, plate potentials of 45 and 90 volts for the tubes of a receiver. In order to reduce

size, the rectifying transformer and filter are made to serve as feet for the base board. This construction is fully illustrated in Figure 2. By this means the amplifier and the plate supply unit are kept more or less separate. The speaker filter together with the four 1 mf by-pass condensers are also placed underneath the baseboard. In the plate supply unit one UX 281 rectifier tube is used. The plate of this tube is connected to one side of the high-voltage secondary of the power transformer. The filament of the rectifier tube, as well as the filament of the UX 250 tube and the heater of the UY 227 tube, are all lighted by means of separate low voltage secondaries of the power transformer. The filter employed is the General Radio Type 527-A Rectifier Filter. This unit is a complete rectifier filter in itself and consists of suitable chokes and condensers. The 1500 ohm section of one of the type 446 voltage dividers is used as the resistance to obtain the bias voltage for the UX 250 tube. The type 214-A 2500 ohm rheostat is used as the biasing resistor for the UY 227 tube. All leads carrying alternating current should be twisted in order to reduce hum and kept as far away as possible from the audio transformers. Both the placement of parts and the actual wiring is clearly shown in the illustrations.

It is best in any amplifier to operate the first-stage tube with the lowest grid bias voltage that is permissible without distorting. The lower the bias voltage of any amplifier tube, assuming of course the same plate voltage, the lower the plate resistance. This means that there will be a greater transfer of voltages, particularly at the low frequencies. The bias voltages of both tubes should be adjusted with a high-resistance voltmeter connected directly across the

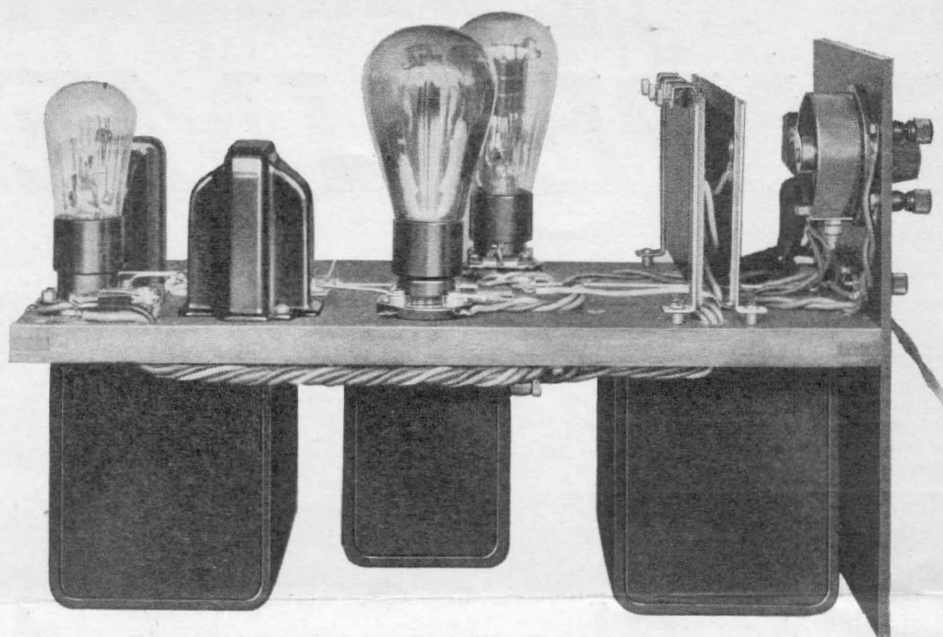

Fig. 2. Side View of Amplifier

biasing resistors. The correct voltage for the UX 250 tube is approximately 80 volts while that of the UY 227 tube is about 4 volts with a plate voltage of 90. Without a proper bias the best audio transformers are no better than the worst. With the right amount of grid bias, the grid is so negative to start with that the positive half of the wave never makes it positive; no grid current ever flows and both halves of the wave are amplified equally.

Several variations of this amplifier suggest themselves. For instance, it might be advisable in some cases to employ full wave rectification, especially if this amplifier is used with a receiver that requires considerable plate current. The change from half to full wave rectification involves only a change in transformers and the addition of one socket. At the same time it will be necessary to utilize another low voltage transformer for the heater

of the UY 227 tube. Adequate space has been left on the top of the base-board for additional equipment. In some cases it might be well to add an additional stage of amplification in order to secure a greater output from the UX 250 tube. In the amplifier illustrated it was thought best not to utilize the full possibilities of the UX 250 tube, thus removing any tendency for this tube to distort on account of flow of grid current and at the same time leaving a large reserve of volume available for modulation peaks.

If the full possibilities of the UX 250 tube are to be realized it is suggested that a two-stage double impedance coupled amplifier precede it. Since the frequency characteristic of the double impedance coupler is essentially flat, it is recommended that the tubes employed in the impedance amplifier, or in all cases where a two stage amplifier precedes the UX 250 tube, be UX 201-A or UX 112 tubes operated by a storage battery. This is on account of the sensitivity of a multi-stage amplifier which will tend to amplify any hum that might be present in the AC tubes or the leads to them. Further, in a multi-stage amplifier too much stress cannot be laid on the advantage of parallel plate feed or chokes in the various plate leads of the amplifier to prevent coupling and in general make the amplifier more stable.

It is no secret that one of the serious limitations of the use of AC

(Continued on page 4, column 1)

List of Parts

1 General Radio type 565A Transformer	1 UX 250 or CX 350 tube
1 General Radio type 527A Filter	1 UX 281 or CX 381 tube
1 General Radio type 537A Speaker Filter	1 UY 227 or C 327 tube
1 General Radio type 285 D Transformer	1 Baseboard 8 x 16 x 3/4"
1 General Radio type 285H Transformer	1 Piece bakelite 8 x 11 1/4 x 3/16"
2 General Radio type 439 Center tap resistance	7 Binding posts
1 General Radio type 438 Socket	1 Toggle switch
2 General Radio type 446 Voltage divider	4 -1 mf condensers
1 General Radio type 214A 2500 ohm Resistor	1 Cord and plug
2 General Radio type 349 Sockets	
1 General Radio, type 437 Adjustable center tap resistance	



PARALLEL PLATE FEED

By C. T. BURKE, Engineering Department

The use of a parallel feed, i. e., a separation of the direct current and alternating current paths in the plate circuit of a vacuum tube, certainly has no claim to novelty. This system of connection has not, however, achieved the popularity to which its merit would seem to entitle it. So far the set builder is familiar with the circuit only as associated with the loudspeaker, where the use of the so-called "speaker filter" has become general. The parallel plate circuit applies the principle of the speaker filter to the audio amplifier. The circuit is illustrated in fig. 1.

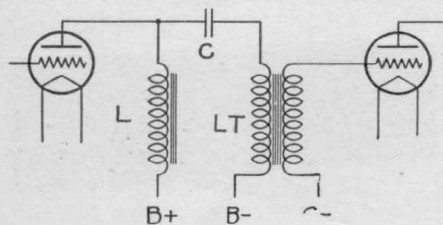

Figure 1.

L is an inductance of high value. It must be of such construction as to maintain its inductance at currents of several milliamperes. C is a condenser of sufficiently large capacity to offer a low impedance at low frequency. The direct plate current flows through the choke L, which has a low impedance to direct current, while the condenser offers an effective bar to the flow of direct current through the primary of the transformer. Alternating current is prevented from flowing through the choke L in appreciable amount by its high impedance, while the condenser and transformer primary offer a path of low impedance as compared with that offered by the choke. In this way the two components of current existing in the plate circuit of the tube, i. e. the space current (constant and unidirectional), and the audio frequency signal current are directed into different circuits.

The separation of the direct and alternating components of the plate current of a vacuum tube is desirable for a number of reasons. Direct current flowing through the primary of a transformer sets up a field in the core which may cause magnetic saturation in the core. Saturation is a condition under which changes in magnetizing current do not produce

corresponding changes in flux. Since the operation of the transformer is dependent on changes in flux, the instrument is naturally affected. The better the transformer, the more likely is this to happen. If the transformer's core is of silicon steel, saturation is not likely to occur with tubes of the 01A or 99 type, but if a 112 or 227 tube is used, saturation may occur and is certain to occur if tubes of the -71 or -10 type are used to feed the transformer. Cores of nickel steel such as are coming to be used to an increasing extent are much more subject to this difficulty than are silicon cores.

Currents of more than a few milliamperes will seriously affect the behavior of the nickel steel transformer, and the instrument may easily be permanently injured by the application of too large a direct current magnetizing force. The effect of saturation of the iron is to reduce the input impedance of the instrument, resulting in a loss of amplification particularly marked at low frequency. When using cores of some of the nickel alloys, the gain due to the special core material may be completely sacrificed as a result of too much direct current in the primary.

The elimination of oscillation and motor-boating in the amplifier is another advantage gained by the use of parallel feed. It has been noted that the signal current does not flow through the direct current circuit, i. e., no signal or audio frequency current flows through the plate supply unit. Since no signal current from any stage flows through the plate supply, no audio frequency voltages are set up, and no coupling between the stages results from the common impedance. The result is a great increase in the stability of the amplifier, and an elimination of regeneration and "motor-boating."

Another advantage of the parallel feed system is that it permits the use of auto-transformers for coupling. An auto-transformer is one having a continuous winding, with a tap for the primary, instead of two separate windings. Since the primary of this type of transformer is common to a portion of the secondary, the auto transformer cannot be used in the

ordinary amplifier, where the primary of the transformer must serve to transmit both alternating and direct current, because of the direct current potential which would be impressed on the grid of the following tube.

This type of transformer offers a considerable improvement in efficiency over the two winding type. A General Radio type 285 1:2.7 transformer will have a ratio of nearly 1:4 when connected as an auto transformer, and there is no loss in "quality."

It is desirable to have the voltage across the transformer primary as high as possible, and this consideration determines the values of L and C. It will be noted from the diagram that the voltage across the transformer primary will be smaller than that across L by the amount of the drop through C. It is, therefore, important to have the drop through the condenser small. This is accomplished by making the impedance of the condenser small. When the transformer is followed by another vacuum tube, the following rule for the condenser capacity will be found satisfactory:

$$(6.28f)^2 L_T C = 4 \text{ where}$$

f = low frequency cut-off of the system (the point where the amplification curve drops sharply).

L_T = inductance of transformer (Henries)

C Capacitance of the coupling condenser (Farads)

The voltage across the coupling coil is determined by the plate impedance of the tube, and by the effective impedance of the entire parallel system in the plate circuit. The value of inductance is not critical, but it should be such as to have an impedance of several times the plate impedance of the tube or of the transformer (the latter impedances are nearly equal at the low frequency cut off of the system). A rough rule

$$\text{is } L = 4 \frac{R_p}{6.28f}$$

where L = inductance of the coupling coil, R_p plate impedance of the tube, and f low frequency cut off. About 100 henries is the proper value of inductance for use with the usual interstage tubes. A suitable unit for this purpose is the General Radio type 369 coupling impedance.

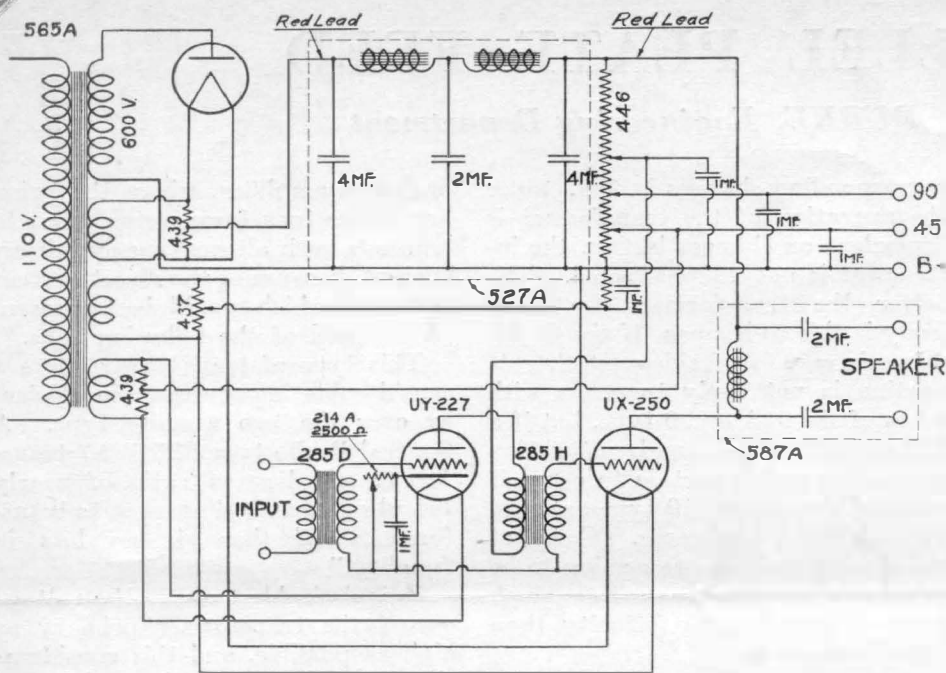

Figure 3. Schematic Diagram of Amplifier

(Continued from page 2, column 3)
tubes is the audio amplifier. If the design of the audio system is such as to allow frequencies below 150 cycles to pass, the alternating current hum becomes a serious factor. In the amplifier just described the use of a UY 227 tube in the first stage together with an efficient rectifier filter has so reduced this hum that without sacrificing the frequency characteristic of the amplifier the hum is not noticeable within two feet of one of the newer types of dynamic cone speaker.

Outside of improper filtering of the rectified AC, the most common cause of hum is magnetic induction from the transformers and chokes into the amplifier or receiver. By carefully changing the angle and distance of the components that go to make up the plate supply, a position can sometimes be found which minimizes magnetic induction. A slight hum is not at all objectionable, but if it can be heard several feet from the loud speaker, something needs attention.

In all cases when using a high grade audio system it is possible that any slight defect elsewhere in the circuit will be noticeably amplified and cause distortion. This is especially true when an AC operated plate supply unit is employed with an amplifier equipped with good audio transformers. The modern audio transformer due to its high efficiency requires more care in the arrangement and wiring of the amplifier than the older types. The more efficient the trans-

formers the greater the tendency for the amplifier to be unstable. Few people realize the amount of feedback or regeneration that may exist in the audio amplifier. Feedback can decrease as well as increase the signals. Even if oscillation is not present, regeneration may cause distortion by increasing or decreasing the volume of one or more frequencies. In case of difficulty of this sort merely reversing the leads to the primary of the second audio transformer may result in stable operation.

(N. B. Equivalent Cunningham tubes may be used interchangeably with the Radiotrons mentioned herein).

Condenser Licensees

The following companies have been issued licenses by the General Radio Company under all or part of the features covered by U. S. Patent No. 1,542,995, pertaining to methods of variable air condenser construction.

American Bosch Magneto Corporation

Amrad Corporation

Brandes Products Corporation

Samson Electric Company

Scovill Manufacturing Company

Silver-Marshall Company, Inc.

Stromberg - Carlson Telephone Mfg. Company

Condenser Plate License

The Scovill Manufacturing Company of Waterbury, Connecticut, have issued to the General Radio Company a license under U. S. Pat-

ent No. 1,258,423. This patent was issued on March 5, 1918 to Fritz Lowenstein and covers the shaping of variable air condenser plates so as to give predetermined frequency variations, as opposed to uniform capacity variations such as would be obtained with semi-circular plates.

Equalizer Panels

An interesting example of the special work which the General Radio laboratories are frequently undertaking is to be found in the equalizer panel shown in the two illustrations. Such an instrument is used to modify and improve the transmission characteristics of a telephone line or perhaps an amplifying system and, in the present case, consists of two resonant circuits having natural frequencies of 3000 and 5000 cycles.

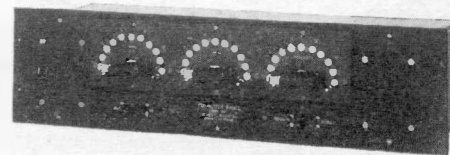

Figure 1. Front View of Equalizer

When such a resonant circuit, comprising a capacity and a low-loss inductance unit in parallel, is connected across the line, it acts as a shunt having a very high impedance at the resonant frequency and an increasingly lower impedance at frequencies away from the resonant value. The sharpness of the resonant or "transmission" curve can be adjusted to any desired amount by the three-dial resistance box inserted in series with the resonant circuit across the line. One of the telephone keys on the panel serves to cut in or out the equalizer, while the other selects either the 3000 or the 5000-cycle circuit. The same condenser is used for both resonant circuits, while each circuit has its individual inductance unit of the proper value.

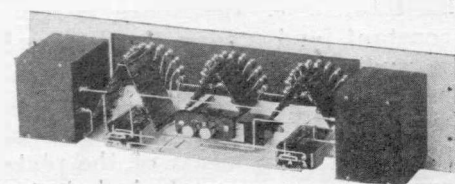

Figure 2. Rear View of Equalizer

Equipment of this sort having any desired specifications can be made on special order.